

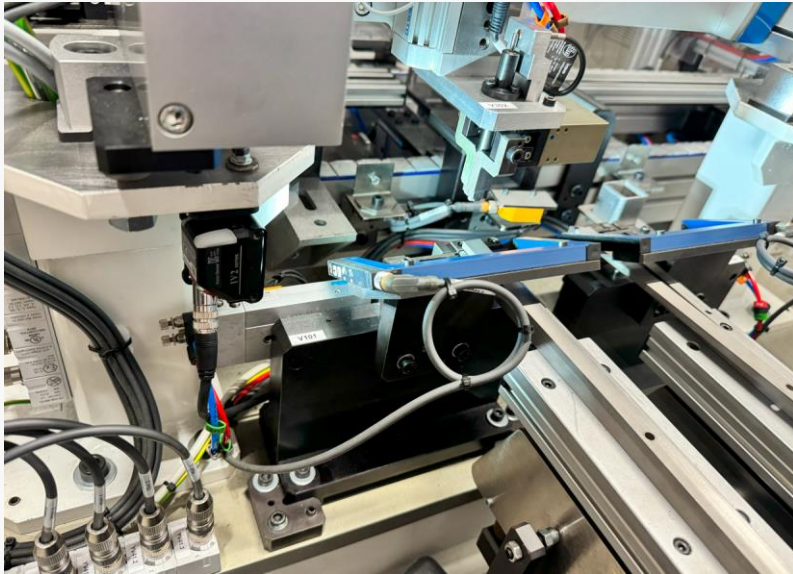

innovative & lean industrial solutions

ABOUT US

Our **vision** is to be the primary partner for businesses seeking tailored production solutions to be align with the customers' unique requirements. We envision a future where every client achieves innovative, efficiency and success through with our customized turnkey projects.



Our philosophy is to pioneer **innovative industrial solutions** with **quality & precise machining** service.

We are committed to being a trusted partner, guiding our clients to new heights of productivity, reliability and competitiveness in their respective markets.



Our **mission** is to empower our clients by delivering turnkey projects that transcend traditional industry standards. Through attentive collaboration and cutting – edge technology, we strive to understand and fulfill each customer's certain needs, providing them with innovative solutions that drive their production capabilities forward.



LOCATIONS & ORGANISATION



ATATECH SRL



Branch – Iasi / ROMANIA

Municipiul IASI, Bulevardul Independentei, Nr 1,
Scara A, Etaj 1, Ap 1, Judet IASI / ROMANIA

info@atatech.ro



Freelancer
Software
Developer



Mechanical
Support



Technical
Investigation



ATATECH PRO

Headquarter – Bursa / TÜRKİYE

Alaaddinbey Mh, Çiftlik (380) Cd, No 5/F
Nilüfer - BURSA / TÜRKİYE

info@atatech.pro



Designing
Development



Machining /
Production



Automation
& Software
Development



Assembly



OUR APPROACH & CAPABILITIES

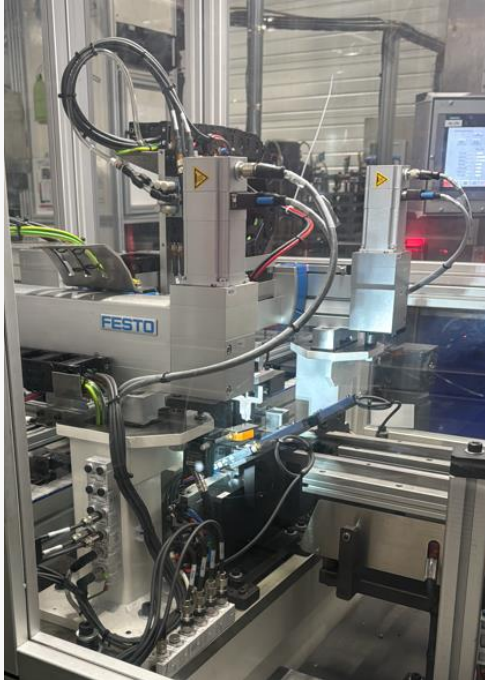

Understanding Your Needs

- Detailed consultation process to grasp client requirements.

Consultation & Planning

- Initial discussions to understand requirements.

Customization

- Tailoring solutions to meet specific production challenges.

Innovation

- Implementing cutting-edge technologies for efficiency and quality.

Implementation & Support

- Installation, testing, and ongoing maintenance.



- Flexible Support Services & Customized Engineering
- Specialized Production & Turnkey Projects
- Advanced Technologies Integration
- Precision Machining

- ✓ Standalone Stations
- ✓ Vision Control & Measurement System
- ✓ Mechanical Implementations – Fixtures - Revisions
- ✓ PLC - PC – Traceability - Automation Software Developments



DESIGNING

✓ Design & Development

Professional 3D designing regarding to the process needs & creating tailored solutions with client input.

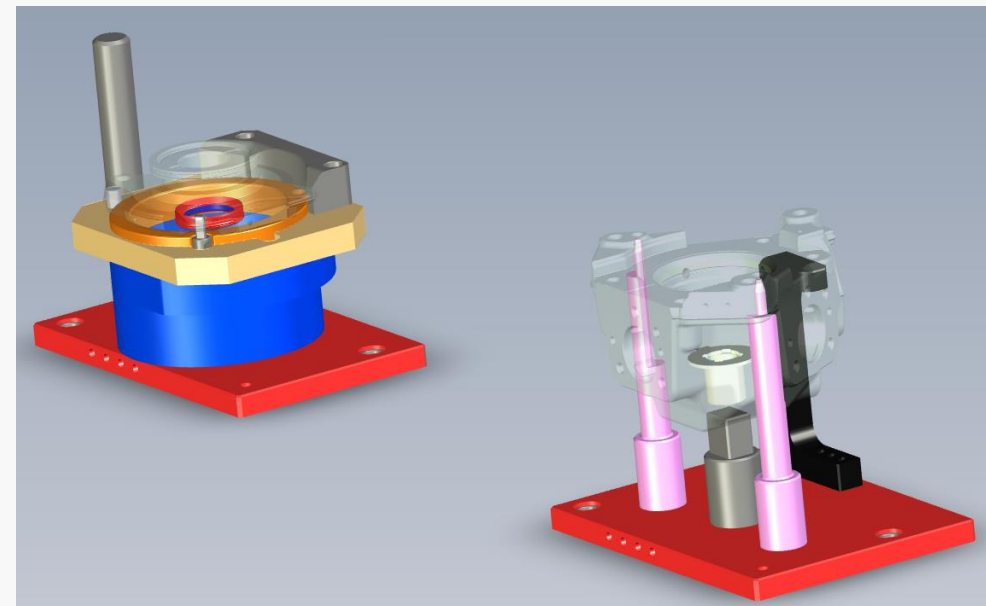
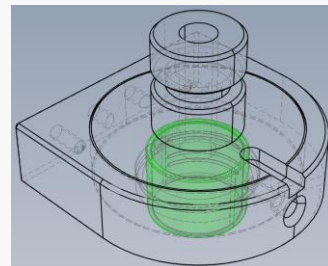
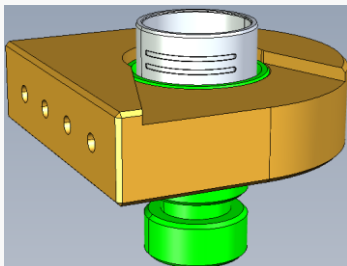
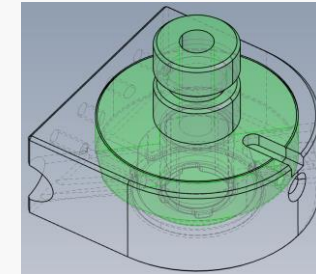
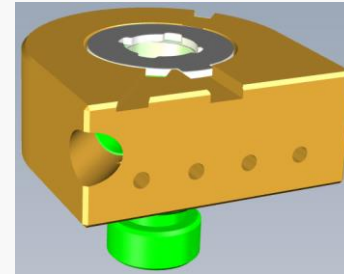
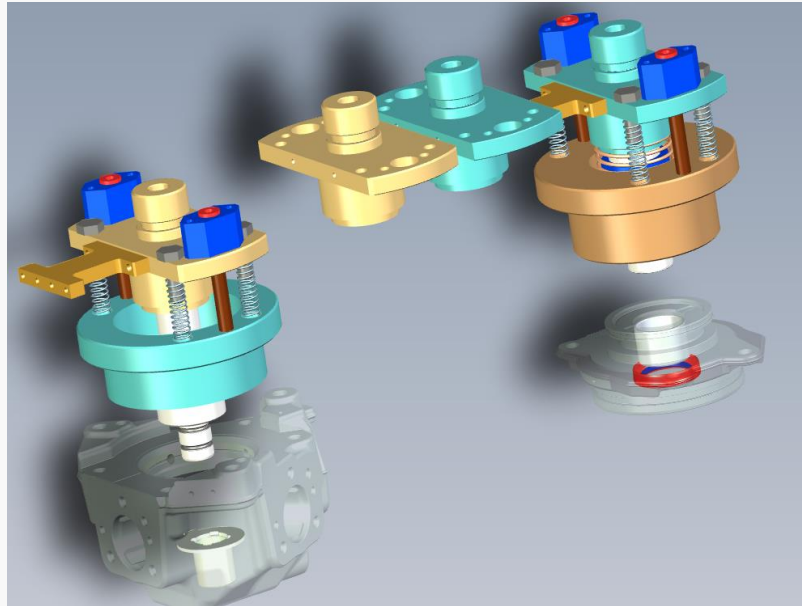

MACHINING & PRECISION PRODUCTION

- ✓ Providing high product variability, tough quality control requirements, demand for rapid production scalability.



QUALITY & ASSEMBLY

- ✓ Longlife material, high material quality, rapid production and prompt assembling.

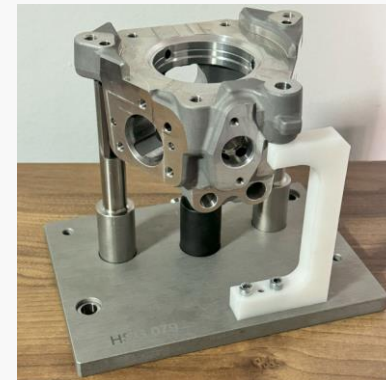
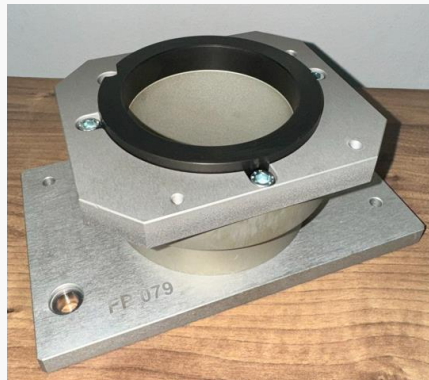
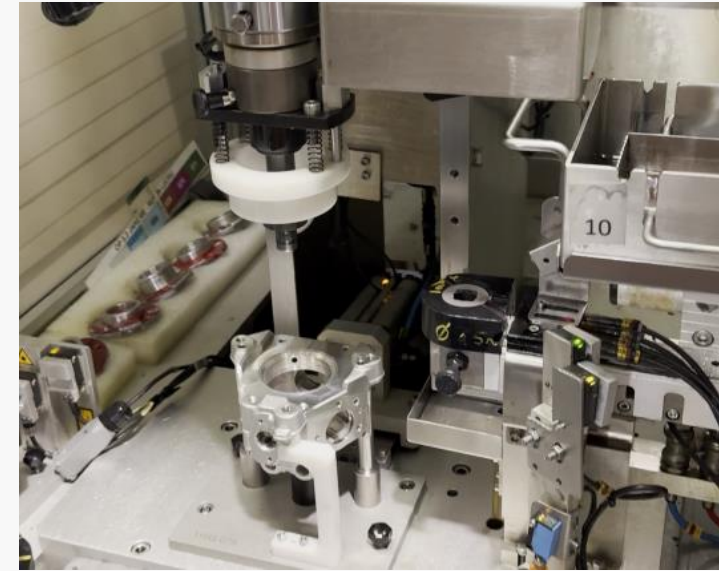
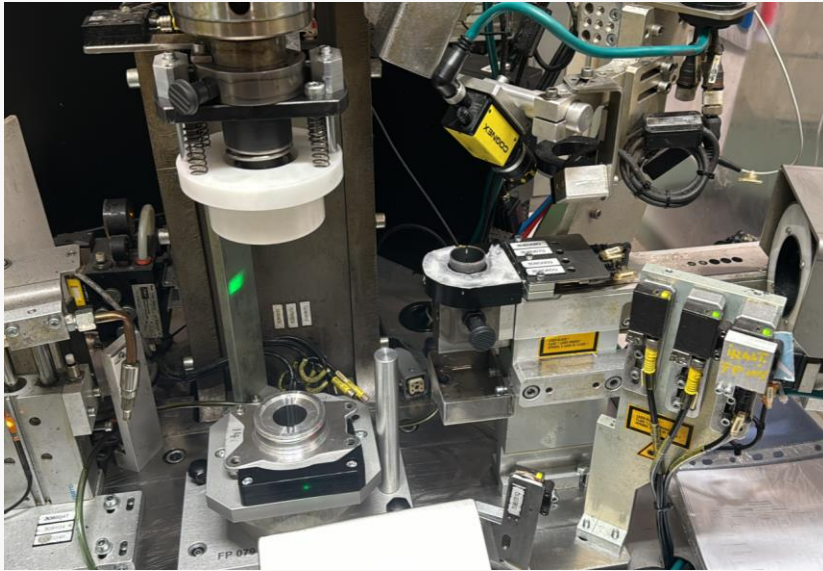

AUTOMATION & SUPPORT

- ✓ Custom electrical system based on components of the equipment and automation support with precision engineering.

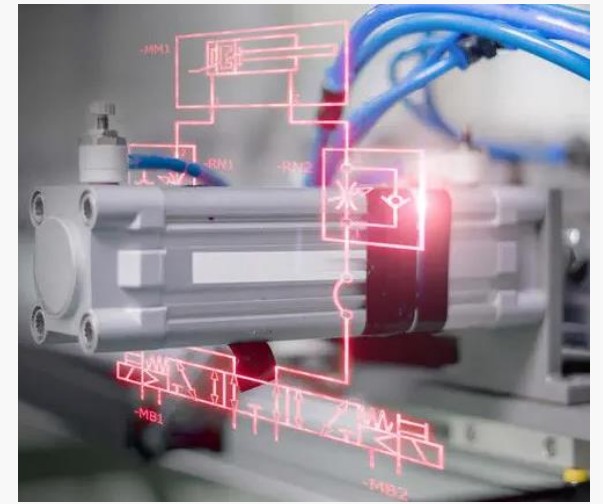

PROJECTS

Software implementation on site and remote support

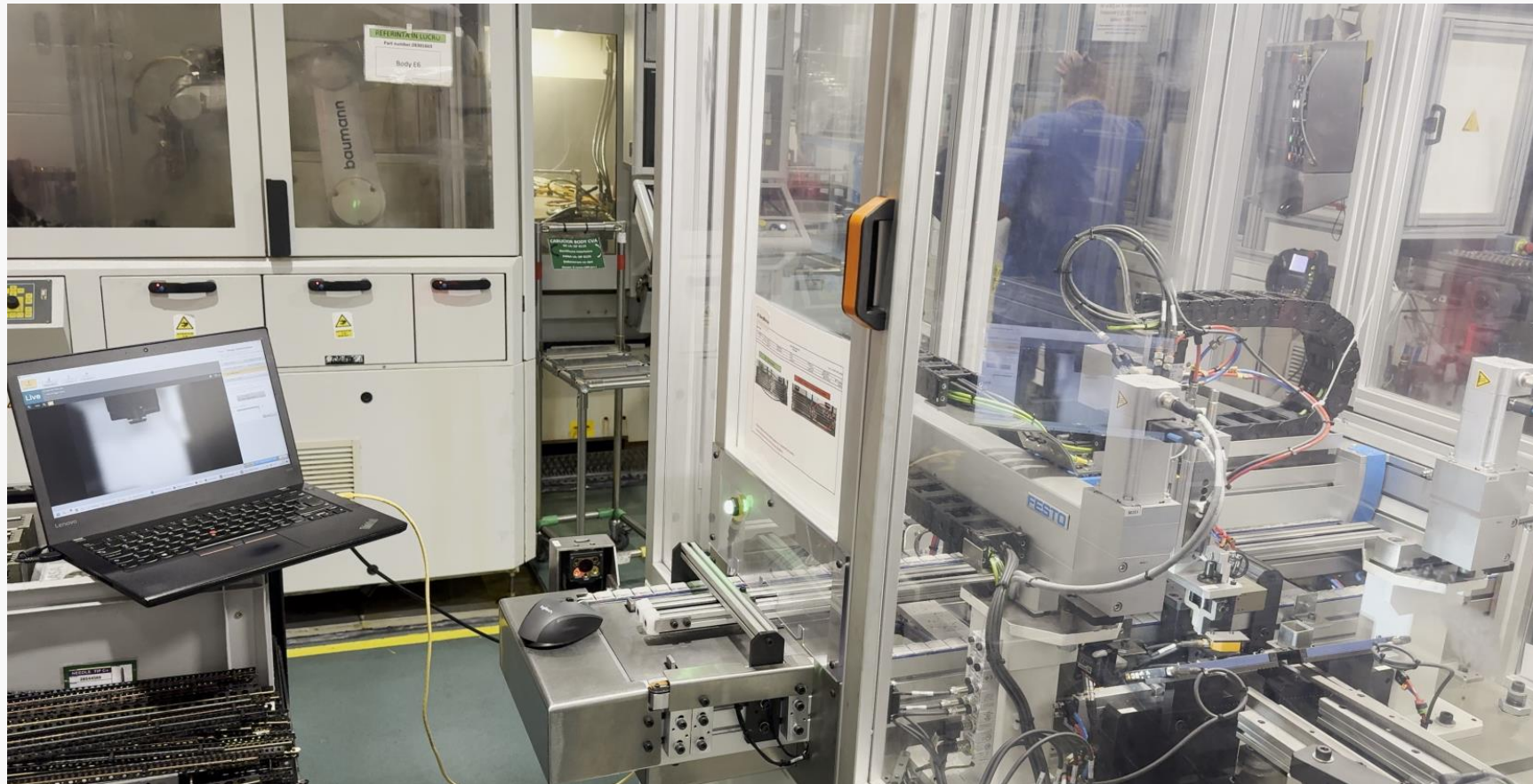

PROJECTS

Camera implementation at customer site

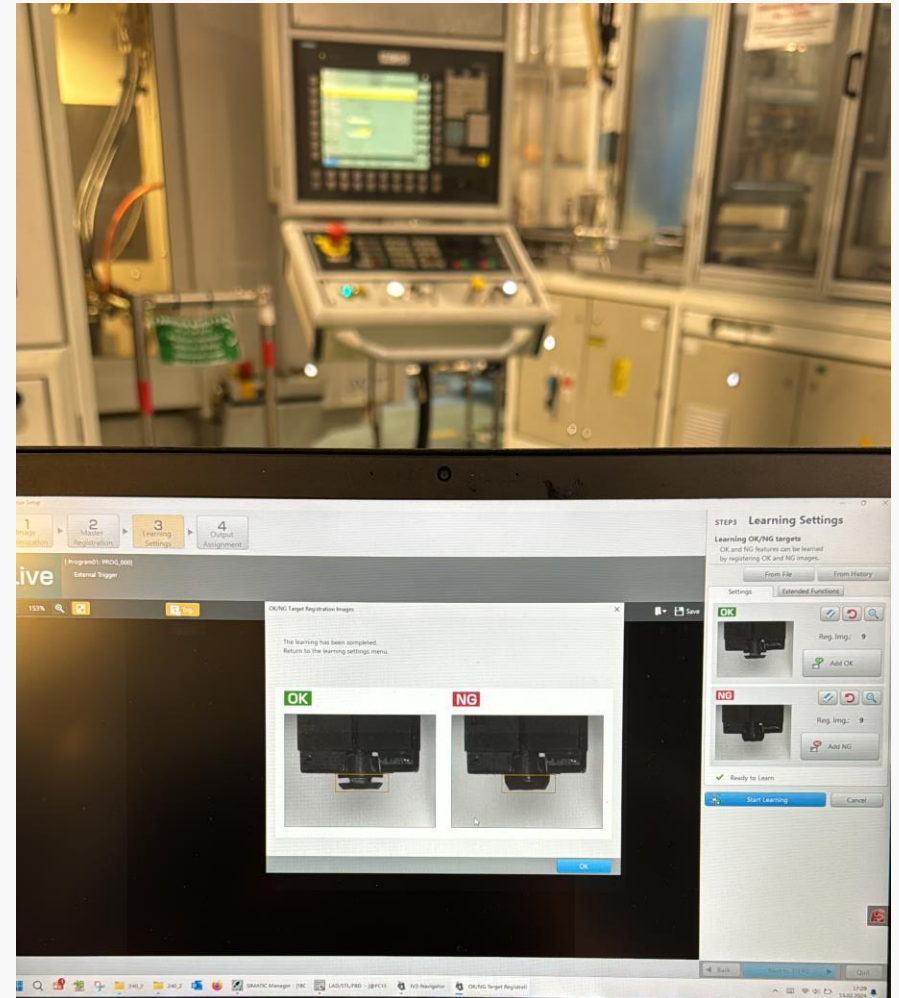
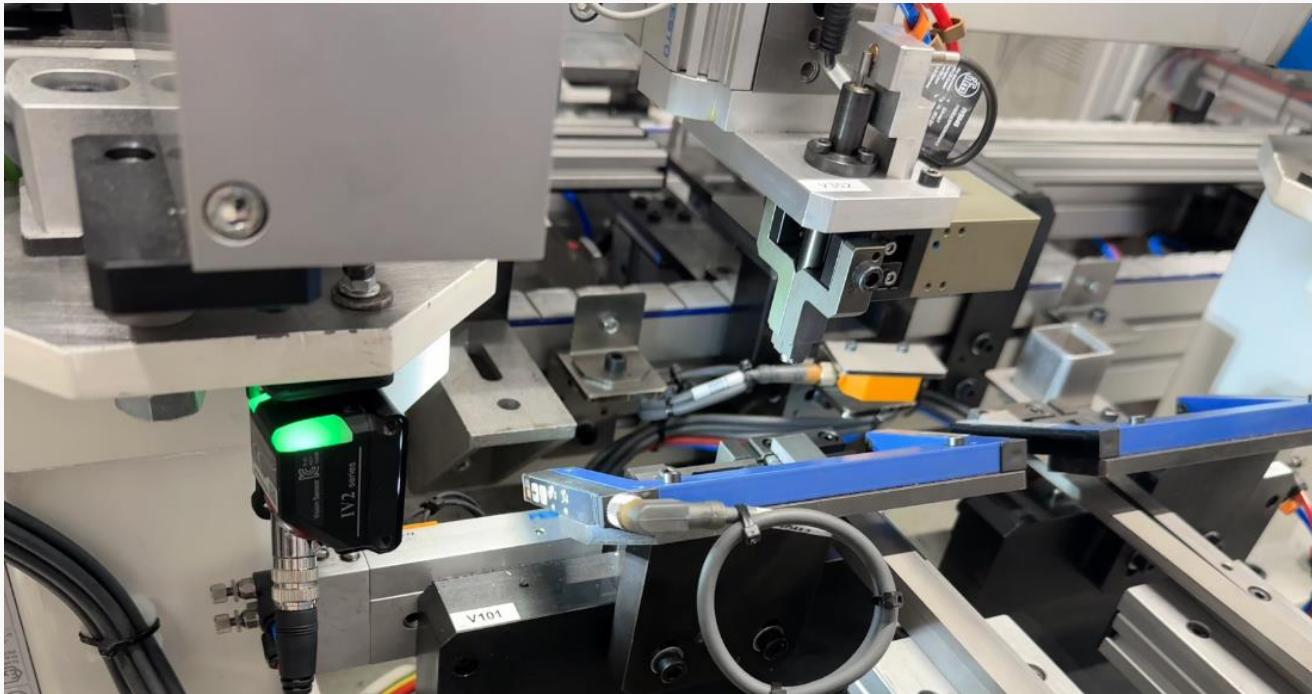

PROJECTS

PC and PLC software revisions in parallel with the integrated customer MES system.

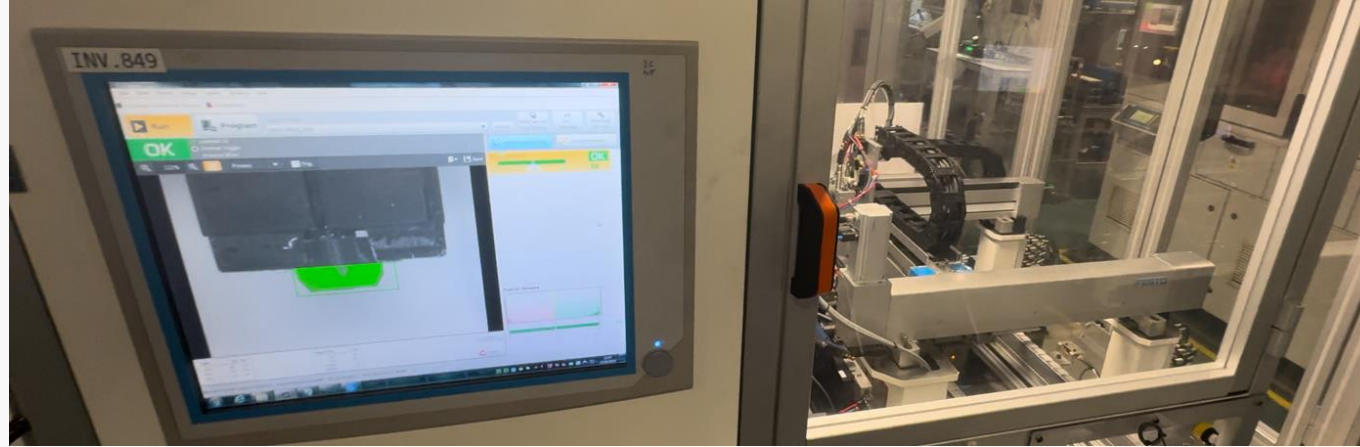

PROJECTS

Engineering support in every field of projects.



PROJECTS

Providing common production solutions that can be used at different standalone stations.



REFERENCES

